



Design Example Report

Title	<i>High Efficiency ($\geq 85\%$), High Power Factor (> 0.9) 15 W T8 Isolated LED Driver Using LinkSwitch™-PH LNK406EG</i>
Specification	90 VAC – 265 VAC Input; 50 V, 0.3 A Output
Application	LED Driver for T8 Lamp
Author	Applications Engineering Department
Document Number	DER-256
Date	October 7, 2010
Revision	1.2

Summary and Features

- Low profile design, <10 mm component height
 - Allows driver board to sit behind LEDs giving uniform illumination in a T8 replacement tube application
- Superior performance and end user experience
 - Clean monotonic start-up – no output blinking
 - Fast start-up (<200 ms) – no perceptible delay
- Highly energy efficient
 - $\geq 86\%$ at 115 VAC and $\geq 87\%$ at 230 VAC
- Low cost, low component count and small printed circuit board footprint solution
 - No current sensing required
 - Frequency jitter for smaller, lower cost EMI filter components
- Integrated protection and reliability features
 - Output open circuit / output short-circuit protection with auto-recovery
 - Line input overvoltage shutdown extends voltage withstand during line faults
 - Auto-recovering thermal shutdown with large hysteresis protects both components and printed circuit board
 - No damage during brown-out or brown-in conditions
- Meets IEC 61000-3-2 Class C harmonics and EN55015 B conducted EMI

PATENT INFORMATION

The products and applications illustrated herein (including transformer construction and circuits external to the products) may be covered by one or more U.S. and foreign patents, or potentially by pending U.S. and foreign patent applications assigned to Power Integrations. A complete list of Power Integrations' patents may be found at www.powerint.com. Power Integrations grants its customers a license under certain patent rights as set forth at <http://www.powerint.com/ip.htm>.

**Power Integrations**Tel: +1 408 414 9200 Fax: +1 408 414 9201
www.powerint.com

Table of Contents

1	Introduction	4
2	Power Supply Specification	6
3	Schematic	7
4	Circuit Description	8
4.1	Input EMI Filtering and Protection	8
4.2	LinkSwitch-PH Primary	8
4.2.1	Bias Winding and Output OVP Sense	9
4.3	Output Voltage Sense	9
4.4	Output Rectification	9
5	PCB Layout	10
6	Bill of Materials	12
7	Transformer Specification	14
7.1	Electrical Diagram	14
7.2	Electrical Specifications	14
7.3	Materials	14
7.4	Transformer Build Diagram	15
7.5	Transformer Construction	15
8	Transformer Design Spreadsheet	16
9	Performance Data	19
9.1	Efficiency vs. Line	19
9.2	Constant Current vs. Line	21
9.3	Power Factor vs. Line, Full Load	22
10	Thermal Performance	24
11	Harmonic Data	26
12	Waveforms	28
12.1	Input Line Voltage and Current	28
12.2	Drain Voltage and Current	28
12.3	Output Voltage and Ripple Current	29
12.4	Drain Voltage and Current Start-up Profile	29
12.5	Output Current and Drain Voltage at Shorted Output	30
12.6	Open Load Output Voltage	30
13	Conducted EMI	31
14	Radiated EMI	33
15	Revision History	34

Important Note: Although this board is designed to satisfy safety isolation requirements, the engineering prototype has not been agency approved. Therefore, all testing should be performed using an isolation transformer to provide the AC input to the prototype board.



1 Introduction

The document describes a power factor corrected LED driver designed to drive a nominal LED string voltage of 50 V at 0.3 A from an input voltage range of 90 VAC to 265 VAC. The LED driver uses the LNK406EG from the LinkSwitch-PH family by Power Integrations.

LinkSwitch-PH ICs allow the implementation of cost effective and low component count LED drivers which meet both power factor and harmonics limits; and also offer an enhanced end user experience. This includes ultra-wide dimming range (not used in this demo), flicker free operation (even with low cost AC line TRIAC dimmers) and fast, clean turn on.

The topology used is an isolated flyback operating in continuous conduction mode. Output current regulation is sensed entirely from the primary side eliminating the need for secondary side feedback components. No external current sensing is required on the primary side either as this is performed inside the IC further reducing components and losses. The internal controller adjusts the MOSFET duty cycle to maintain a sinusoidal input current and therefore high power factor and low harmonic currents.

The LNK406EG also provides a sophisticated range of protection features including auto-restart for open control loop and output short-circuit conditions. Line overvoltage provides extended line fault and surge withstand, output overvoltage protects the supply should the load be disconnect and accurate hysteretic thermal shutdown ensures safe average PCB temperatures under all conditions.

The key goals of this design were low profile and high efficiency. This was to allow the driver board to fit into the space behind the LED load board inside a T8 tube and operate with an acceptable temperature rise. This necessitated careful selection of components and mounting methods but was simpler than alternate solutions due to the low component count required for a primary side regulated LinkSwitch-PH design.

This document contains the LED driver specification, schematic, PCB diagram, bill of materials, transformer documentation and typical performance characteristics.





Figure 1 – Populated Circuit Board Photograph (Top View).



Figure 2 – Populated Circuit Board Photograph (Bottom View), Board Dimensions 260.44 mm x 19.53 mm

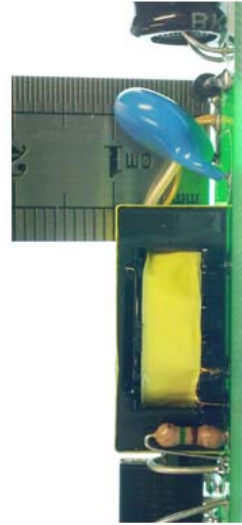

Figure 3 – Component Height (10 mm).

2 Power Supply Specification

The table below represents the minimum acceptable performance of the design. Actual performance is listed in the results section.

Description	Symbol	Min	Typ	Max	Units	Comment
Input						
Voltage	V_{IN}	90	115/230	265	VAC	2 Wire – no P.E.
Frequency	f_{LINE}	47	50/60	64	Hz	
Output						
Output Voltage	V_{OUT}	45	50	55	V	
Output Current	I_{OUT}		0.3		A	
Total Output Power						
Continuous Output Power	P_{OUT}		15		W	
Efficiency						
Full Load	η	85			%	Measured at 115 / 230 VAC
Environmental						
Conducted EMI		Meets CISPR 15B / EN55015B				
Radiated EMI		FCC Class B / EN55015				
Safety		Designed to meet IEC950 / UL1950 Class II				
Power Factor		0.9				Measured at $V_{OUT(TYP)}$, $I_{OUT(TYP)}$ and 115 VAC / 230 VAC
Harmonics		EN 61000-3-2 Class C and D				
Board Dimensions		260.44 x 19.53 x 13 (10)			mm	Designed to fit behind LED load board in T8 tube. 13 mm total height including PCB and load protrusions, 10 mm max component height above PCB
Ambient Temperature	T_{AMB}		40		°C	Free convection, sea level



4 Circuit Description

The LinkSwitch-PH device is an integrated controller plus 725 V power MOSFET intended for use in LED driver applications. The LinkSwitch-PH is configured for use in a single-stage continuous conduction mode flyback topology and provides a primary side regulated constant current isolated output while maintaining high power factor from the AC input.

4.1 Input EMI Filtering and Protection

Fuse F1 provides protection from catastrophic component failure while RV1 (MOV) provides a clamp to limit the maximum component voltage stress during differential line surges. The use of a MOV is more critical in this design as the value of input capacitance is low. The low value of capacitance results in a much larger increase in the rectified bus voltage (across C2) for a given differential surge level. A 275 VAC rated part was selected, being slightly above the maximum specified operating voltage of 265 VAC. Diode bridge BR1 rectifies the AC line voltage with capacitor C2 providing a low impedance path (decoupling) for the primary switching current. A low value of capacitance (sum of C1, C2 and C3) is necessary to maintain a power factor of greater than 0.9.

EMI filtering is provided by inductors L1, L2, L3 and L4, C1 and Y1 safety rated C8. Resistor R1, R2 and R3 across L2, L3 and L4 dampen any resonance between the input inductors, capacitors and the AC line impedance which would otherwise be measured as increased conducted EMI.

4.2 LinkSwitch-PH Primary

Diode D1 and C3 detect the peak AC line voltage. This voltage is converted to a current which is fed into the V pin via R5, R6 and R7. This current is also used by the device to set the input over/under voltage protection thresholds. The V pin current and the FB pin current are used internally to control the average output LED current. The non-dimming mode of LinkSwitch was selected via a 24.9 k Ω resistor on the R pin. In the non-dimming configuration LinkSwitch-PH is optimized for line regulation, maintaining a fixed output current across the entire input voltage range. Resistor R8 also sets the internal references to select the brown-in and brown-out and input overvoltage protection thresholds. Resistor R7 provides further line compensation and in this design achieves line regulation of $\pm 3\%$.

One end of the flyback transformer is connected to the DC bus while the other is driven by the integrated 725 V power MOSFET within U1. During the power MOSFET on time the primary current ramps up, storing energy in the transformer. This energy is transferred to the secondary when the power MOSFET turns off. An EER25 core was selected for low profile and used a triple insulated secondary winding with flying leads to meet safety spacing requirements.



Diode D2, R17, C12 and R18 clamp the drain voltage to a safe level due to the effect of a leakage inductance voltage spike seen on the drain at turn off. Diode D3 is necessary to prevent reverse current from flowing through the LinkSwitch-PH device when the voltage across the primary (V_{OR} or flyback voltage), exceeds the voltage across C2 and the instantaneous input AC sine wave.

4.2.1 Bias Winding and Output OVP Sense

Diode D5, C5, R13 and R11 create a supply from the bias winding on the transformer. This voltage supplies the operating current into the BYPASS pin of U1 through D4 and R9. Capacitor C4 provides local decoupling for the BYPASS pin. It is also used during startup, being charged to ~6 V from an internal high-voltage current source tied to the device DRAIN pin. Once charged the energy stored is used to operate U1 until the output reaches regulation.

Diode D6, R16, C7, R14, VR2, C6, R12, and Q1 provide an open load overvoltage protection function. Should the output load be disconnected then the output voltage increases, also causing the bias voltage to rise and therefore the voltage across C7. A separate diode and lower value capacitor are used to rectify the bias winding (D6 and C7) to reduce the delay before OV is triggered and therefore limit the maximum output voltage. Once the voltage across C7 exceeds the threshold set by VR2 (~33 V) Q1 is biased on, reducing the current into the FB pin to below the auto-restart threshold. Once auto-restart mode is entered switching is alternately disabled and enabled keeping the output voltage within acceptable limits until the load is reconnected. This protects output capacitors, C9 and C10 from excessive voltage should the load be disconnected e.g. during manufacturing testing.

4.3 Output Voltage Sense

A current proportional to the output voltage is fed into the FEEDBACK pin through R10 from the primary bias supply. This current together with the V pin current is used to maintain the average output current to be constant with changes in input and output voltage.

4.4 Output Rectification

Diode D7 rectifies the secondary winding while capacitors C9 and C10 filter the output. A small pre-load is provided by R15 which limits the output voltage under no-load conditions. Inductor L5 is used to reduce radiated EMI.



5 PCB Layout

The PCB was designed such that the driver board can be placed directly behind the LED load PCB and still fit within a T8 tube. This required some specific considerations.

- 1 mm PCB thickness
 - Selected to increase height available for components
- SMD component orientation
 - As the board was long and thin the board flexed significantly when handled. To prevent component damage due to mechanical stress all SMD components were oriented on the board such that the long edge of the component is at 90 degrees to the long edge of the board.
- SMD components on top side of PCB only
 - No SMD parts were placed on the bottom side of the PCB to reduce overall board height – the low component count of LinkSwitch-PH solutions makes meeting this requirement much simpler.



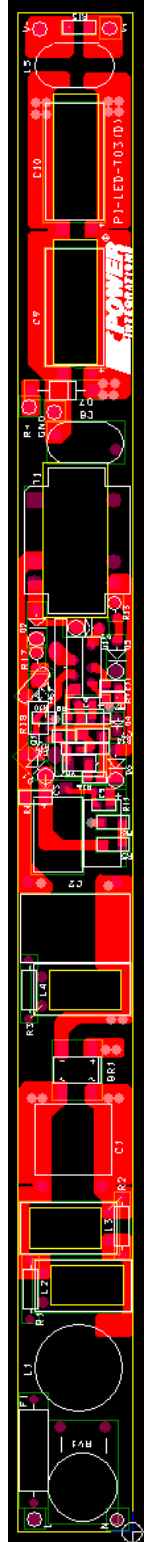

Figure 5 – Printed Circuit Layout (Top).

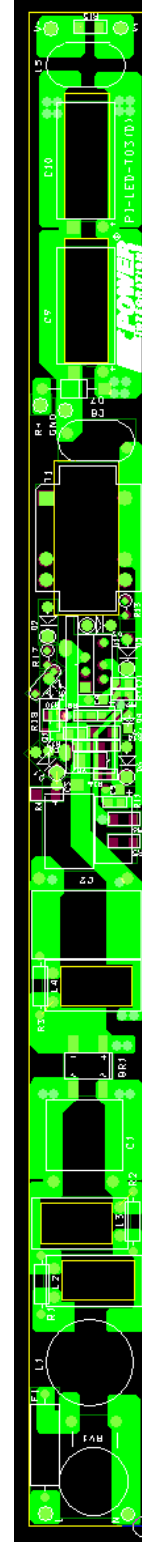

Figure 6 – Printed Circuit Layout (Bottom).

6 Bill of Materials

Item	Qty	Ref Des	Description	Value
1	1	BR1	600 V, 1 A, Bridge Rectifier, Glass Passivated	DB106S
2	1	C1	47 nF, 275 VAC, Film, X2	47 nF
3	1	C2	100 nF, 400 V, Film	100 nF
4	1	C3	1 μ F, 400 V, Electrolytic, (6.3 x 11)	1 μ F
5	1	C4	100 μ F, 25 V, Electrolytic, Low ESR, 130 m Ω , (6.3 x 11)	100 μ F
6	1	C5	22 μ F, 50 V, Electrolytic, Low ESR, 900 m Ω , (5 x 11.5)	22 μ F
7	2	C6 C11	100 nF, 50 V, Ceramic, X7R, 0805	100 nF
8	1	C7	1.0 μ F, 50 V, Ceramic, X7R, 1206	1.0 μ F
9	1	C8	2.2 nF, Ceramic, Y1	2.2 nF
10	2	C9 C10	100 μ F, 63, Electrolytic, Low ESR, 255 m Ω , (10 x 12.5)	100 μ F
11	1	C12	1 nF, 1 kV, Disc Ceramic	1 nF
12	2	D1 D6	1000 V, 1 A, Rectifier, DO-41	1N4007
13	2	D2 D5	1000 V, 1 A, Fast Recovery, 500 ns, DO-41	FR107
14	1	D3	200 V, 1 A, Ultrafast Recovery, 50 ns, DO-41	MUR120
15	1	D4	75 V, 0.15 A, Fast Switching, DO-35	LL4148
16	1	D7	600 V, 1 A, Ultrafast Recovery, 75 ns, DO-41	MUR160
17	1	F1	3.15 A, 250 V, Slow	3.15 A
18	1	L1	4 mH, 0.2 A, T13, U10000, 35 turns	4 mH
19	3	L2 L3 L4	1000 μ H, 0.18 A, 8 x 10 mm	1000 μ H
20	1	L5	300 μ H, 1 A, T8, U10000, 10turns	300 μ H
21	1	Q1	NPN, 60 V 1000 MA, SOT-23	FMMT491
22	3	R1 R2 R3	4.7 k Ω , 5%, 1/4 W, Carbon Film	4.7 k Ω
23	1	R4	240 k Ω , 5%, 1/4 W, Metal Film, 1206	240 k Ω
24	1	R5	1.8 M Ω , 1%, 1/4 W, Metal Film, 1206	1.8 M Ω
25	1	R6	1.6 M Ω , 1%, 1/4 W, Metal Film, 1206	1.6 M Ω
26	1	R7	1.8 M Ω , 1%, 1/8 W, Metal Film, 0805	1.8 M Ω
27	1	R8	24.9 k Ω , 1%, 1/4 W, Metal Film	24.9 k Ω
28	1	R9	6.2 k Ω , 5%, 1/8 W, Metal Film, 0805	6.2 k Ω
29	1	R10	130 k Ω , 1%, 1/8 W, Metal Film, 0805	130 k Ω
30	1	R11	20 k Ω , 5%, 1/8 W, Metal Film, 0805	20 k Ω
31	1	R12	1 k Ω , 5%, 1/8 W, Metal Film, 0805	1 k Ω
32	1	R13	150 Ω , 5%, 1/8 W, Carbon Film	150 Ω
33	1	R14	10 k Ω , 5%, 1/8 W, Metal Film, 0805	10 k Ω
34	1	R15	56 k Ω , 5%, 1/4 W, Metal Film, 1206	56 k Ω
35	1	R16	100 Ω , 5%, 1/8 W, Metal Film, 0805	100 Ω
36	1	R17	100 Ω , 5%, 1/4 W, Metal Film, 1206	100 Ω
37	1	R18	82 k Ω , 5%, 1/2 W, Carbon Film	82 k Ω
38	1	RV1	275 V, 80J, 10 mm, RADIAL	10D431



39	1	T1	EER25, special low profile, 5 + 5	EER2510
40	1	U1	LinkSwitch-PH, LNK406EG, eSIP	LNK406EG
41	1	VR2	33 V, 5%, 500 mW, DO-213AA (MELF)	ZMM5257B



7 Transformer Specification

7.1 Electrical Diagram

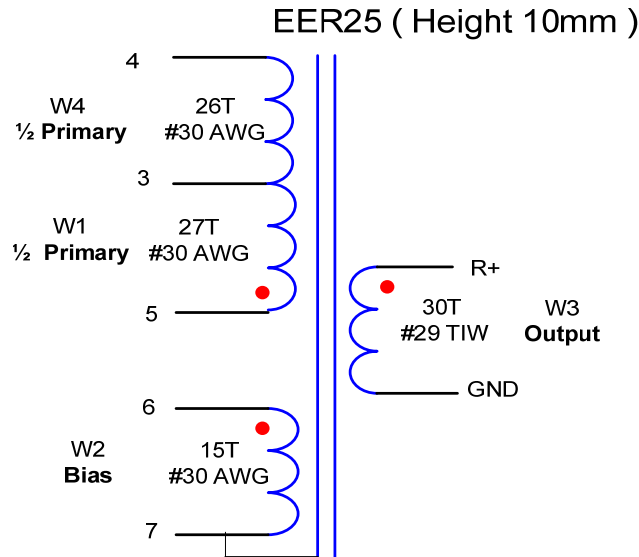

Figure 7 – Transformer Electrical Diagram.

7.2 Electrical Specifications

Electrical Strength	1 second, 60 Hz, from pins 3, 4, 5, 6, 7 to R+, GND	3000 VAC
Primary Inductance	Pin 4-5, all other windings open, measured at 100 kHz, 0.4 VRMS	0.8 mH ±10%
Primary Leakage Inductance	Pin 4-5 with R+, GND shorted, measured at 100 kHz, 0.4 VRMS	20 µH ±10%

7.3 Materials

Item	Description
[1]	Core: PC40 EER25 or equivalent
[2]	Bobbin: 10 pin vertical
[3]	Magnet Wire: #30 AWG.
[4]	Magnet Wire: #29 AWG T.I.W.
[5]	Tape: 3M 1298 Polyester Film, 4 mm wide.



7.4 Transformer Build Diagram

Pins Side

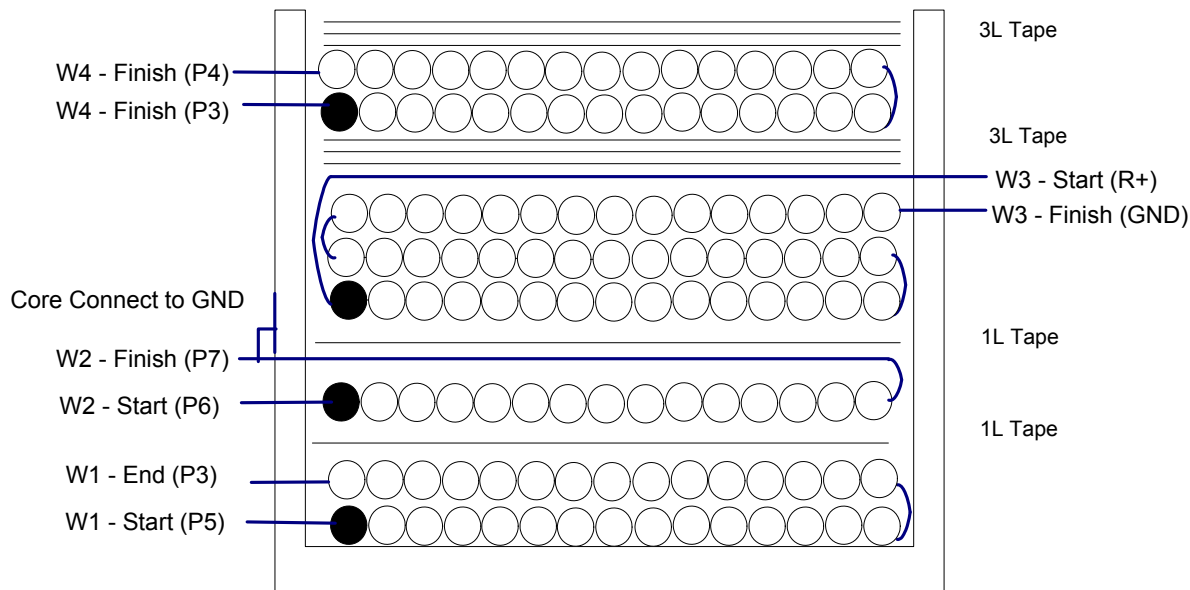

Figure 8 – Transformer Build Diagram.

7.5 Transformer Construction

Bobbin Preparation	Place the bobbin item [2] on the mandrel such that pin side on the left side. Winding direction is the clockwise direction.
WD 1	Start at pin 5, wind 27 turns of #30 AWG item [3] from left to right two layers. Finish at pin 3.
Insulation	Apply one layer of tape [5] for insulation.
WD 2	Start at pin 6, wind 15 turns of #30 AWG [3] wire from left to right. Finish at pin 7. Leave enough length wire floating to connect to core.
Insulation	Apply one layer of tape [5] for insulation.
WD 3	Start at R+ (Fly-lead) of wire item [4], wind 30 turns in three layers. Finish at GND (Fly-lead)
Insulation	Apply one layer of tape [5] for insulation.
WD 4	Start at pin 3, 26 turns of #30 AWG [3] wire from left to right two layers. Finish at pin 4.
Insulation	Apply three layers of tape [5] for insulation.
Final Assembly	Remove floating wire insulator of WD2, connect to core, wrap up with tape, varnish

8 Transformer Design Spreadsheet

ACDC_LinkSwitch-PH_061010; Rev.1.1; Copyright Power Integrations 2010	INPUT	INFO	OUTPUT	UNIT	LinkSwitch-PH_061010: Flyback Transformer Design Spreadsheet
ENTER APPLICATION VARIABLES					
Dimming required	NO		NO		Select 'YES' option if dimming is required. Otherwise select 'NO'.
VACMIN	90		90	V	Minimum AC Input Voltage
VACMAX	265		265	V	Maximum AC input voltage
fL			50	Hz	AC Mains Frequency
VO	50.00			V	Typical output voltage of LED string at full load
VO_MAX			55.00	V	Maximum expected LED string Voltage.
VO_MIN			45.00	V	Minimum expected LED string Voltage.
V_OVP			60.50	V	Over-voltage protection setpoint
IO	0.30				Typical full load LED current
PO			15.0	W	Output Power
n	0.80		0.8		Estimated efficiency of operation
VB	20		20	V	Bias Voltage
ENTER LinkSwitch-PH VARIABLES					
LinkSwitch-PH	LNK406			Universal	115 Doubled/230V
Chosen Device		LNK406	Power Out	22.5W	22.5W
Current Limit Mode	FULL		FULL		Select "RED" for reduced Current Limit mode or "FULL" for Full current limit mode
ILIMITMIN			1.48	A	Minimum current limit
ILIMITMAX			1.69	A	Maximum current limit
fS			66000	Hz	Switching Frequency
fSmin			62000	Hz	Minimum Switching Frequency
fSmax			70000	Hz	Maximum Switching Frequency
IV			38.7	uA	V pin current
RV			3.909	M-ohms	Upper V pin resistor
RV2			1.402	M-ohms	Lower V pin resistor
IFB	130.00		130.0	uA	FB pin current (85 uA < IFB < 210 uA)
RFB1			130.8	k-ohms	FB pin resistor
VDS			10	V	LinkSwitch-PH on-state Drain to Source Voltage
VD	0.50			V	Output Winding Diode Forward Voltage Drop (0.5 V for Schottky and 0.8 V for PN diode)
VDB	0.70			V	Bias Winding Diode Forward Voltage Drop
Key Design Parameters					
KP	1.05		1.05		Ripple to Peak Current Ratio (For PF > 0.9, 0.4 < KP < 0.9)
LP			809	uH	Primary Inductance
VOR	90.00		90	V	Reflected Output Voltage.
Expected IO (average)			0.29	A	Expected Average Output Current
KP_VACMAX		Info	1.28		!!! Info. PF at high line may be less than 0.9. Decrease KP for higher PF
TON_MIN			1.62	us	Minimum on time at maximum AC input voltage
PCLAMP			0.11	W	Estimated dissipation in primary clamp
ENTER TRANSFORMER CORE/CONSTRUCTION VARIABLES					
Core Type	EER2510		EER2510		
Bobbin		#N/A		P/N:	#N/A
AE	0.5400		0.54	cm^2	Core Effective Cross Sectional Area
LE	3.6000		3.6	cm	Core Effective Path Length
AL			#N/A	nH/T^2	Ungapped Core Effective Inductance
BW	4.2		4.2	mm	Bobbin Physical Winding Width
M			0	mm	Safety Margin Width (Half the Primary to Secondary Creepage Distance)
L	4.00		4		Number of Primary Layers
NS	30		30		Number of Secondary Turns
DC INPUT VOLTAGE PARAMETERS					
VMIN			127	V	Peak input voltage at VACMIN



VMAX			375	V	Peak input voltage at VACMAX
CURRENT WAVEFORM SHAPE PARAMETERS					
DMAX			0.42		Minimum duty cycle at peak of VACMIN
IAVG			0.18	A	Average Primary Current
IP			1.04	A	Peak Primary Current (calculated at minimum input voltage VACMIN)
IRMS			0.31	A	Primary RMS Current (calculated at minimum input voltage VACMIN)
TRANSFORMER PRIMARY DESIGN PARAMETERS					
LP			809	uH	Primary Inductance
NP			53		Primary Winding Number of Turns
NB			12		Bias Winding Number of Turns
ALG			283	nH/T^2	Gapped Core Effective Inductance
BM			2917	Gauss	Maximum Flux Density at PO, VMIN (BM<3100)
BP			3530	Gauss	Peak Flux Density (BP<3700)
BAC			1459	Gauss	AC Flux Density for Core Loss Curves (0.5 X Peak to Peak)
ur			#N/A		Relative Permeability of Ungapped Core
LG		#N/A	#N/A	mm	#N/A
BWE			16.8	mm	Effective Bobbin Width
OD			0.31	mm	Maximum Primary Wire Diameter including insulation
INS			0.05	mm	Estimated Total Insulation Thickness (= 2 * film thickness)
DIA			0.26	mm	Bare conductor diameter
AWG			30	AWG	Primary Wire Gauge (Rounded to next smaller standard AWG value)
CM			102	Cmils	Bare conductor effective area in circular mils
CMA			325	Cmils/Amp	Primary Winding Current Capacity (200 < CMA < 600)
LP_TOL			10		Tolerance of primary inductance
TRANSFORMER SECONDARY DESIGN PARAMETERS (SINGLE OUTPUT EQUIVALENT)					
Lumped parameters					
ISP			1.86	A	Peak Secondary Current
ISRMS			0.60	A	Secondary RMS Current
IRIPPLE			0.52	A	Output Capacitor RMS Ripple Current
CMS			120	Cmils	Secondary Bare Conductor minimum circular mils
AWGS			29	AWG	Secondary Wire Gauge (Rounded up to next larger standard AWG value)
DIAS			0.29	mm	Secondary Minimum Bare Conductor Diameter
ODS			0.14	mm	Secondary Maximum Outside Diameter for Triple Insulated Wire
VOLTAGE STRESS PARAMETERS					
VDRAIN			563	V	Estimated Maximum Drain Voltage assuming maximum LED string voltage (Includes Effect of Leakage Inductance)
PIVS			271	V	Output Rectifier Maximum Peak Inverse Voltage (calculated at VOVP, excludes leakage inductance spike)
PIVB			110	V	Bias Rectifier Maximum Peak Inverse Voltage (calculated at VOVP, excludes leakage inductance spike)
FINE TUNING (Enter measured values from prototype)					
V pin Resistor Fine Tuning					
RV1			3.91	M-ohms	Upper V Pin Resistor Value
RV2			1.40	M-ohms	Lower V Pin Resistor Value
VAC1			115.0	V	Test Input Voltage Condition1
VAC2			230.0	V	Test Input Voltage Condition2
IO_VAC1			0.30	A	Measured Output Current at VAC1
IO_VAC2			0.30	A	Measured Output Current at VAC2
RV1 (new)			3.91	M-ohms	New RV1
RV2 (new)			1.40	M-ohms	New RV2
V_OV			318.3	V	Typical AC input voltage at which OV shutdown will be triggered



V_UV			70.8	V	Typical AC input voltage beyond which power supply can startup
FB pin resistor Fine Tuning					
RFB1			131	k-ohms	Upper FB Pin Resistor Value
RFB2			1E+012	k-ohms	Lower FB Pin Resistor Value
VB1			18.0	V	Test Bias Voltage Condition1
VB2			22.0	V	Test Bias Voltage Condition2
IO1			0.30	A	Measured Output Current at Vb1
IO2			0.30	A	Measured Output Current at Vb2
RFB1 (new)			130.8	k-ohms	New RFB1
RFB2(new)			1.00E+12	k-ohms	New RFB2

Note: Actual values used for $R_{V1} = 3.4 \text{ M}\Omega$, $R_{V2} = 1.8 \text{ M}\Omega$. Measured PF at 230 VAC was 0.9.



9 Performance Data

All measurements performed at room temperature. Yokogawa WT210 power meter was used for input power and output power measuring.

9.1 Efficiency vs. Line

V_{IN} (VAC)	P_{IN} (W)	V_o (V)	I_o (A)	P_o (W)	Efficiency (%)
90	16.63	49.53	0.286	14.17	85.18
100	16.97	49.54	0.293	14.52	85.53
110	17.30	49.77	0.300	14.93	86.31
120	17.57	49.87	0.305	15.21	86.57
130	17.72	49.93	0.308	15.38	86.79
140	17.78	49.96	0.310	15.49	87.11
150	17.81	49.97	0.311	15.54	87.26
160	17.78	49.96	0.311	15.54	87.39
170	17.68	49.92	0.310	15.48	87.53
180	17.55	49.87	0.308	15.36	87.52
190	17.39	49.8	0.306	15.24	87.63
200	17.23	49.74	0.304	15.12	87.76
210	17.04	49.68	0.301	14.95	87.76
220	16.83	49.6	0.298	14.78	87.82
230	16.62	49.52	0.294	14.56	87.60
240	16.39	49.53	0.290	14.36	87.64
250	16.12	49.33	0.286	14.11	87.52
265	15.71	49.17	0.279	13.72	87.32



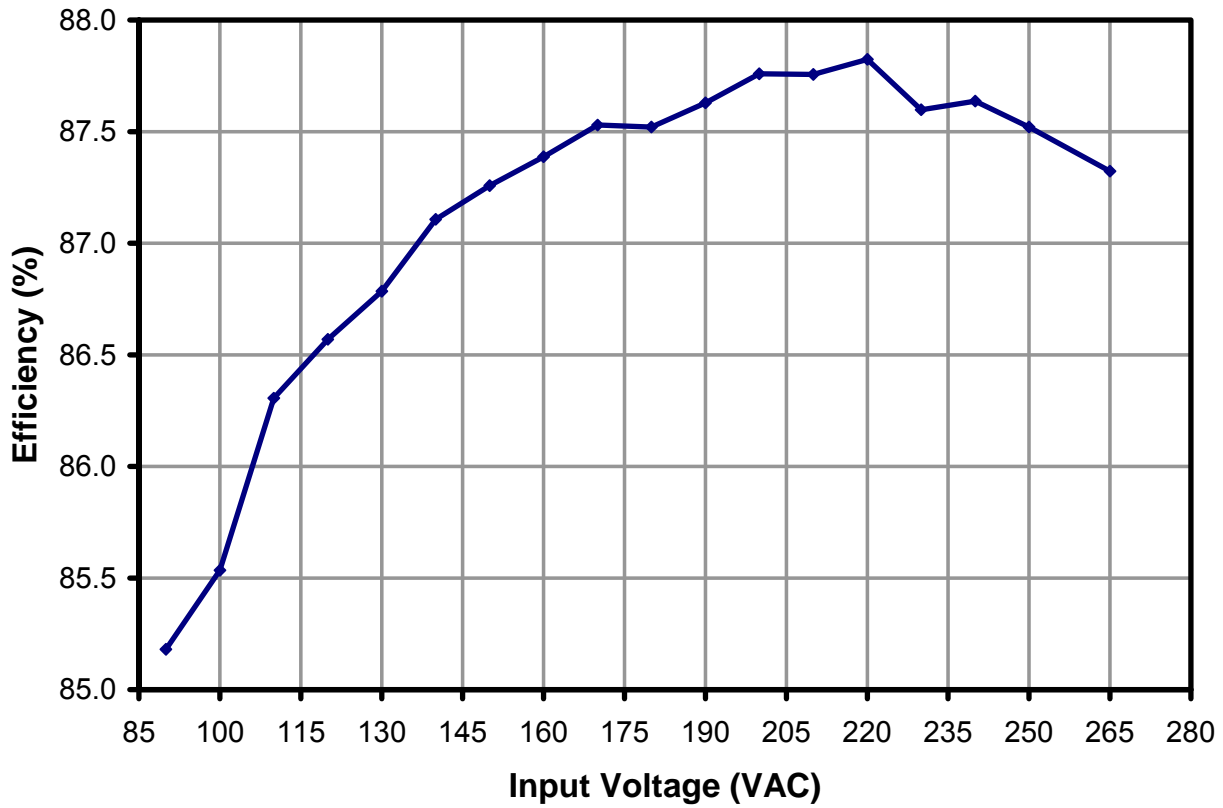

Figure 9 – Efficiency vs. Input Voltage, Room Temperature.



9.2 Constant Current vs. Line

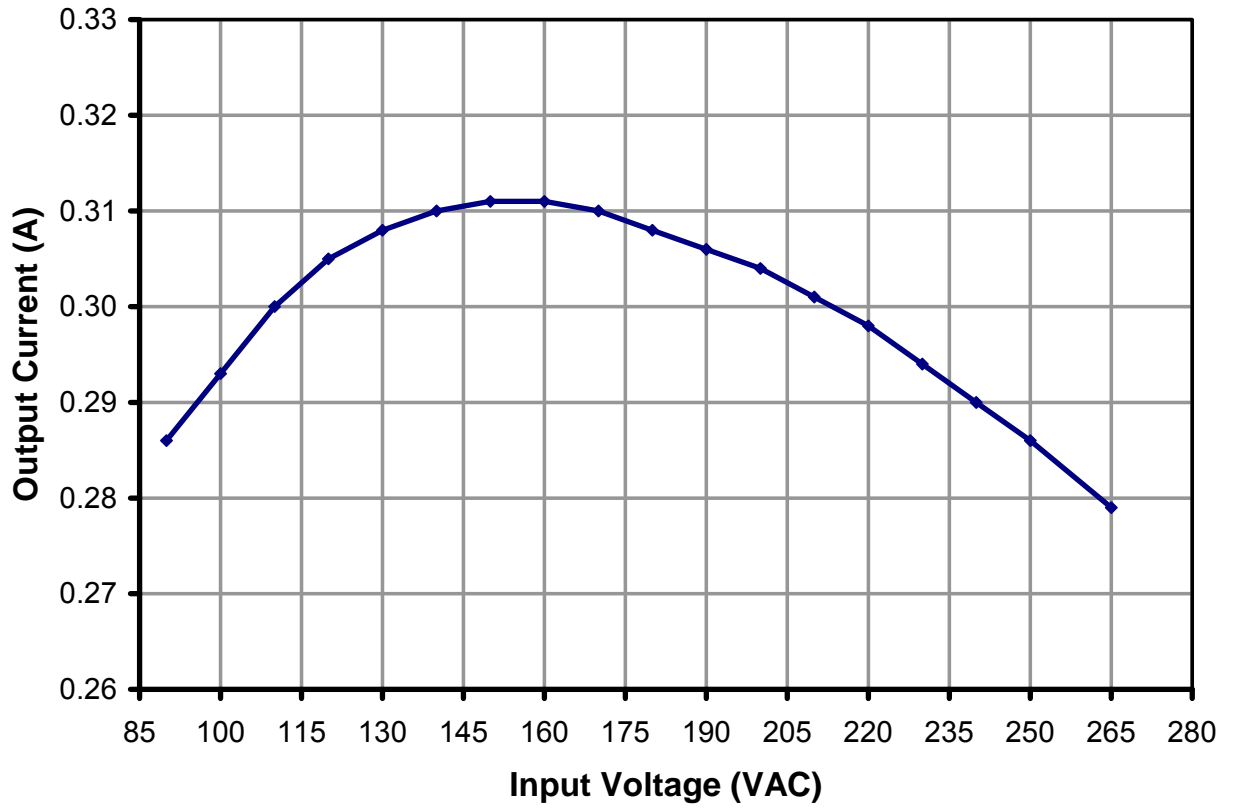

Figure 10 – Output Current vs. Line, Room Temperature.



9.3 Power Factor vs. Line, Full Load

V_{IN} (VAC)	P_{IN} (W)	V_o (V)	I_o (A)	P_o (W)	PF
90	16.63	49.53	0.286	14.17	0.9796
100	16.97	49.54	0.293	14.52	0.9745
110	17.30	49.77	0.300	14.93	0.9715
120	17.57	49.87	0.305	15.21	0.9687
130	17.72	49.93	0.308	15.38	0.966
140	17.78	49.96	0.310	15.49	0.9638
150	17.81	49.97	0.311	15.54	0.9615
160	17.78	49.96	0.311	15.54	0.9592
170	17.68	49.92	0.310	15.48	0.9571
180	17.55	49.87	0.308	15.36	0.955
190	17.39	49.8	0.306	15.24	0.9528
200	17.23	49.74	0.304	15.12	0.9505
210	17.04	49.68	0.301	14.95	0.9484
220	16.83	49.6	0.298	14.78	0.9459
230	16.62	49.52	0.294	14.56	0.9431
240	16.39	49.53	0.290	14.36	0.9401
250	16.12	49.33	0.286	14.11	0.9362
265	15.71	49.17	0.279	13.72	0.9279



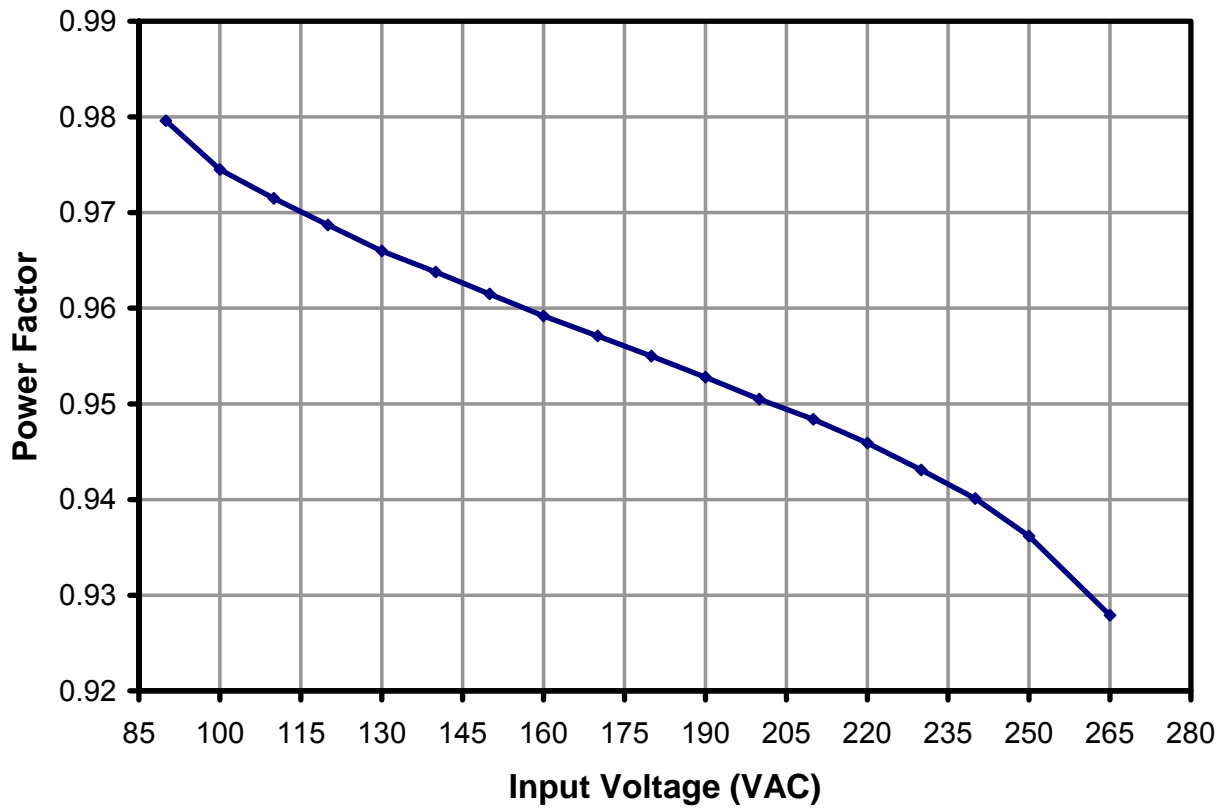

Figure 11 – Power Factor vs. Input Voltage, Room Temperature, Full Load.



10 Thermal Performance

Images captured after running for 30 minutes at room temperature (25 °C), full load (50 V, 0.3 A). This indicates a LinkSwitch-PH (U1) operating temperature of ~80°C at an external board ambient of 40°C. As U1 is the highest temperature component on the board it provides effective thermal protection for the entire system via its internal thermal shutdown. Since there are no components on the bottom side, all the data below are for the top side.

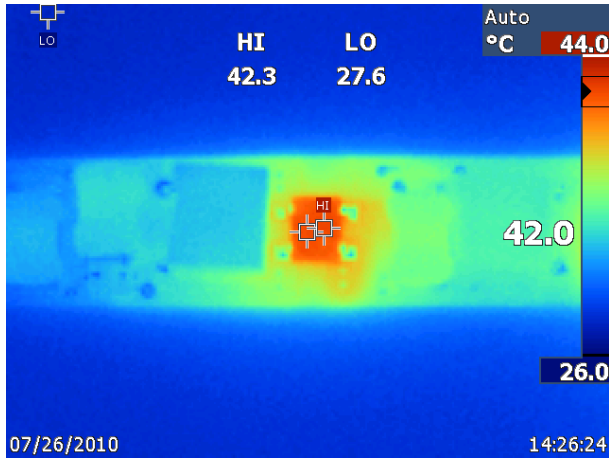

Figure 12 – 115 VAC EMI and Rectifier.

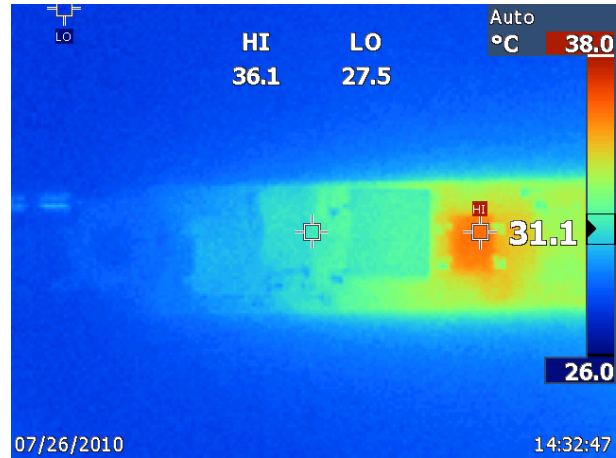

Figure 13 – 230 VAC EMI and Rectifier.

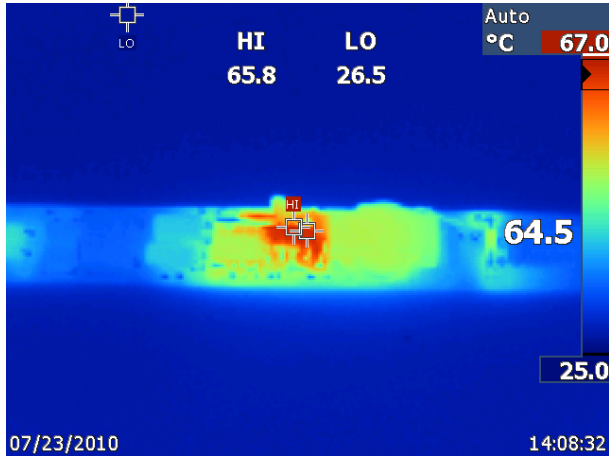

Figure 14 – 115 VAC Main Switching and Transformer.

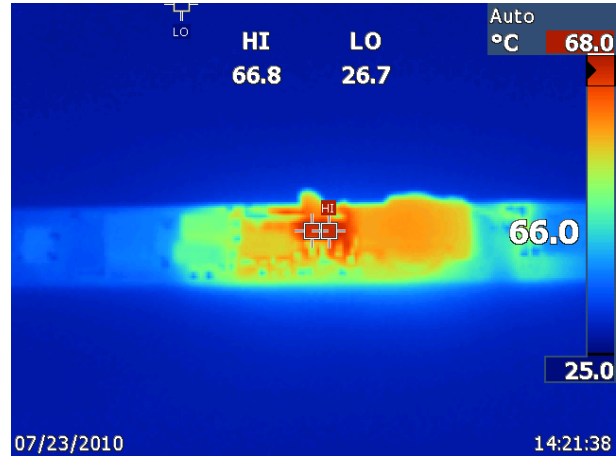

Figure 15 – 230 VAC Main Switching and Transformer.

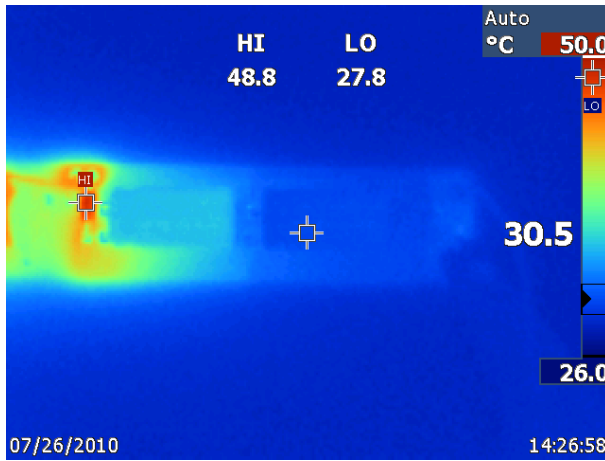

Figure 16 – 115 VAC Output Rectifier.

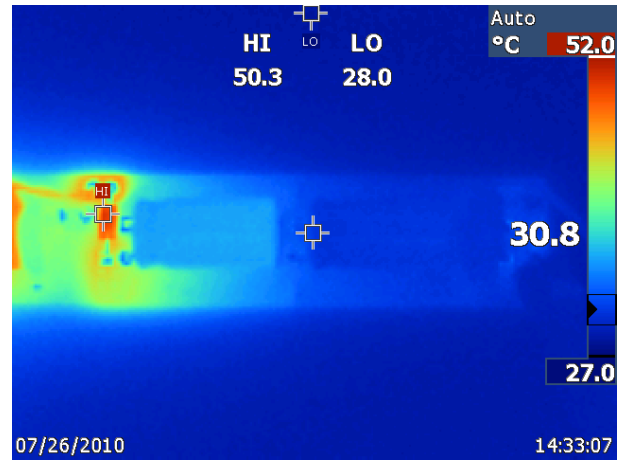

Figure 17 – 230 VAC Output Rectifier.



11 Harmonic Data

The design passes IEC61000-3-2 Class C requirement.

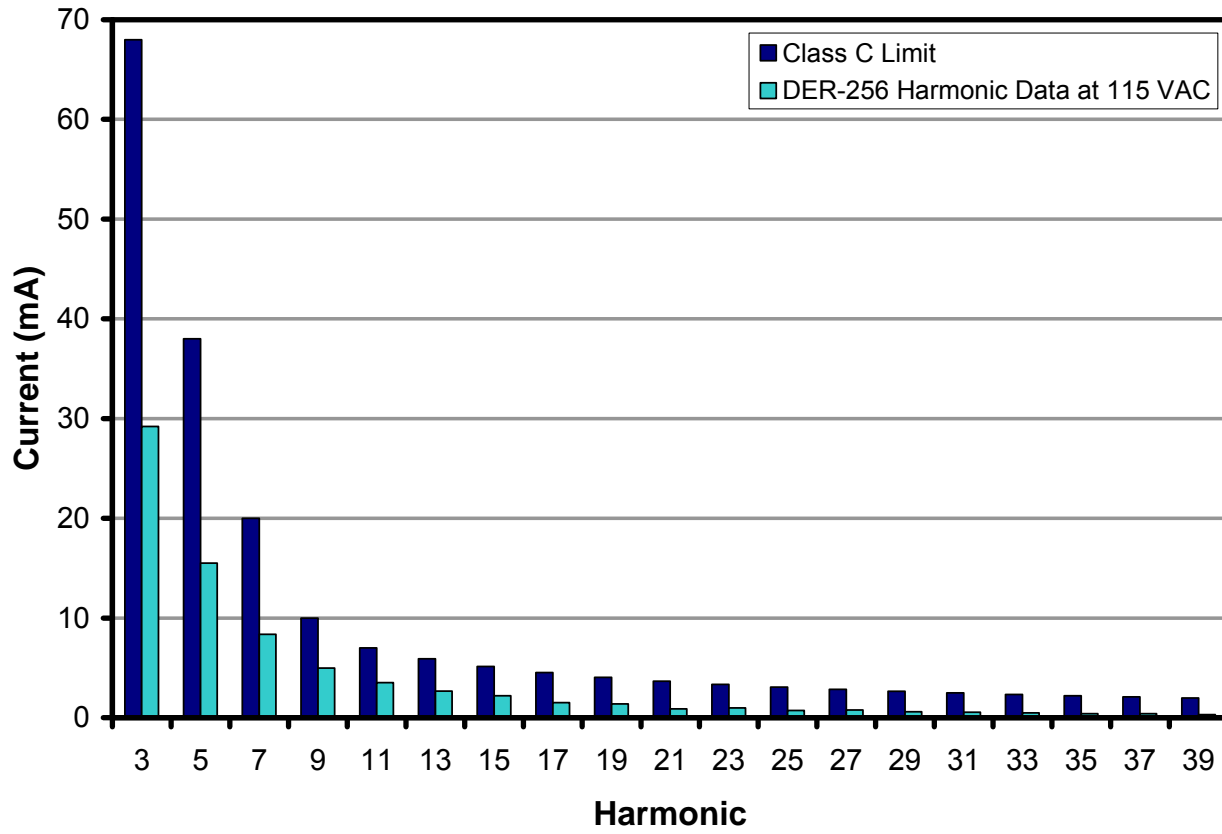

Figure 18 – 115 VAC Harmonic, Room Temperature, Full Load.



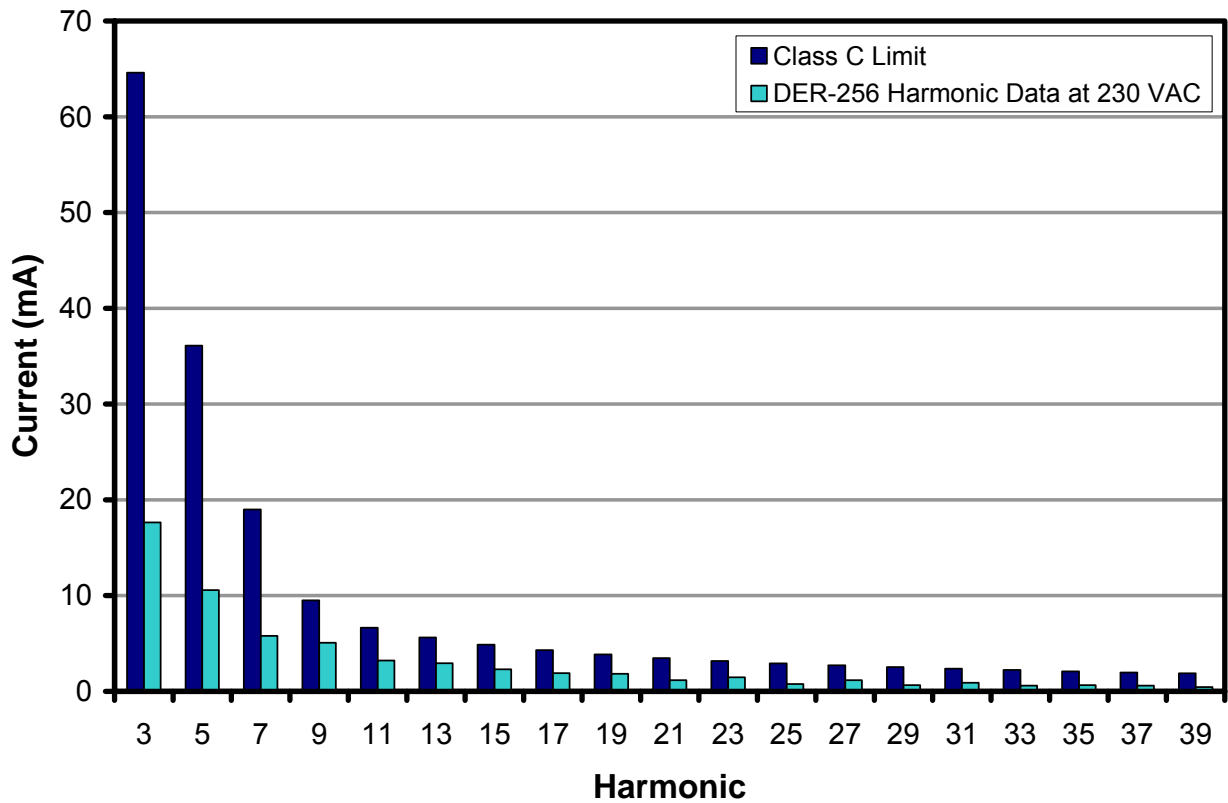

Figure 19 – 230 VAC Harmonic, Room Temperature, Full Load.



12 Waveforms

12.1 Input Line Voltage and Current

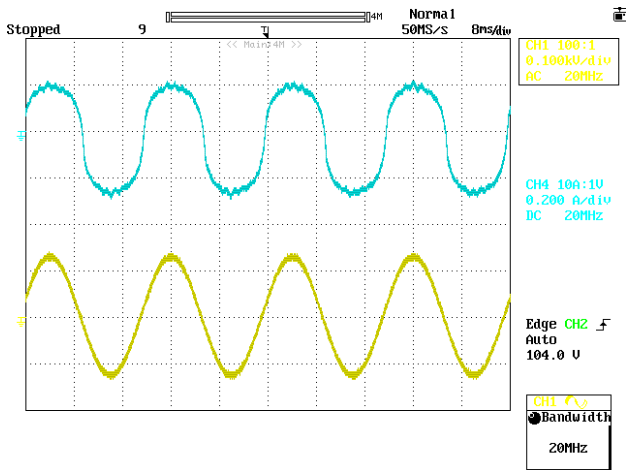

Figure 20 – 90 VAC, Full Load.
Upper: I_{IN} , 0.2 A / div.
Lower: V_{IN} , 100 V, 8 ms / div.

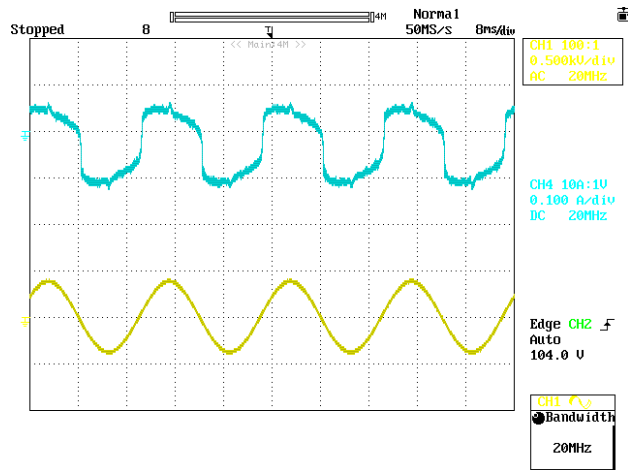

Figure 21 – 265 VAC, Full Load.
Upper: I_{IN} , 0.1 A / div.
Lower: V_{IN} , 500 V / div., 8 ms / div.

12.2 Drain Voltage and Current

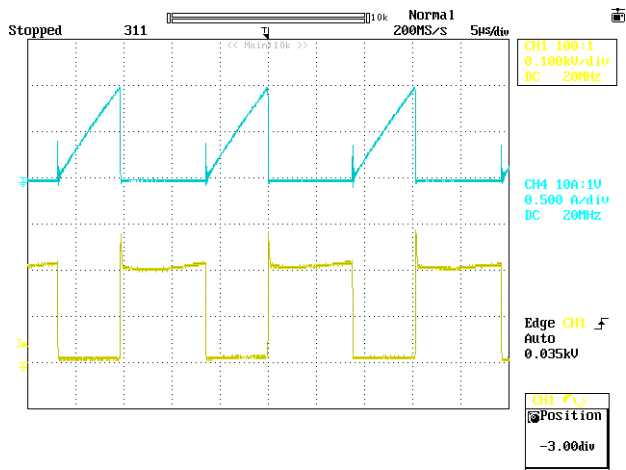

Figure 22 – 90 VAC, Full Load.
Upper: I_{DRAIN} , 0.5 A / div.
Lower: V_{DRAIN} , 100 V, 5 µs / div.

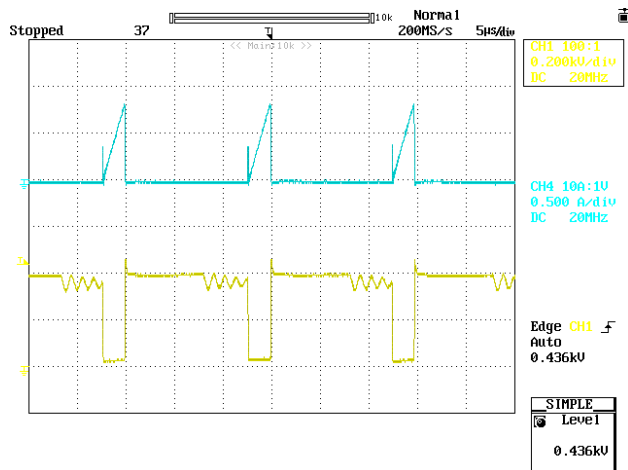

Figure 23 – 265 VAC, Full Load.
Upper: I_{DRAIN} , 0.5 A / div.
Lower: V_{DRAIN} , 200 V / div., 5 µs / div.



12.3 Output Voltage and Ripple Current

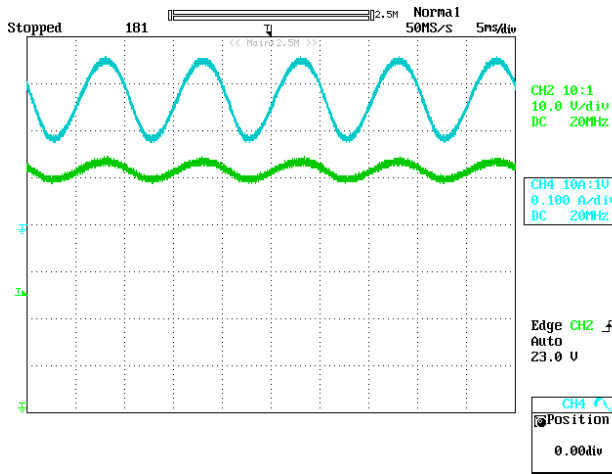

Figure 24 – 90 VAC, Full Load.
 Upper: I_{RIPPLE} , 0.1 A / div.
 Lower: V_{OUTPUT} 10 V, 5 ms / div.

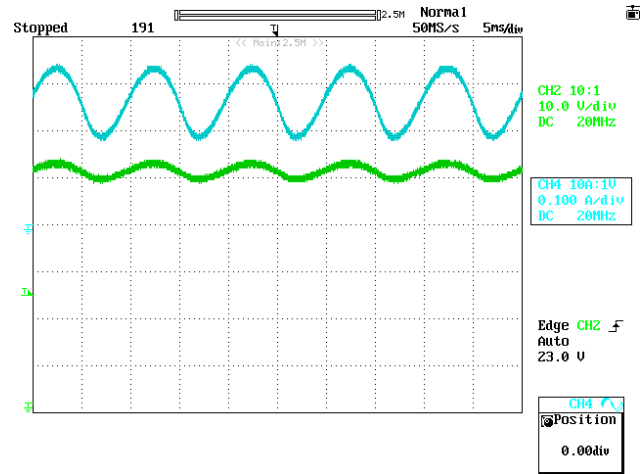

Figure 25 – 265 VAC, Full Load.
 Upper: I_{RIPPLE} , 0.1 A / div.
 Lower: V_{OUTPUT} 10 V, 5 ms / div.

12.4 Drain Voltage and Current Start-up Profile

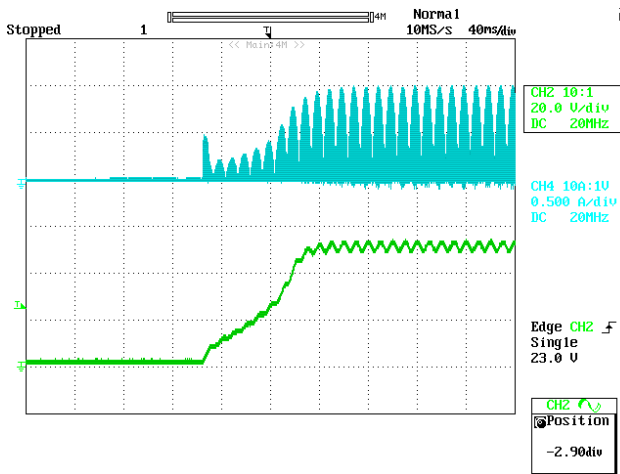

Figure 26 – 90 VAC, Full Load.
 Upper: I_{DRAIN} , 0.5 A / div.
 Lower: V_{OUTPUT} , 20 V, 40 ms / div.

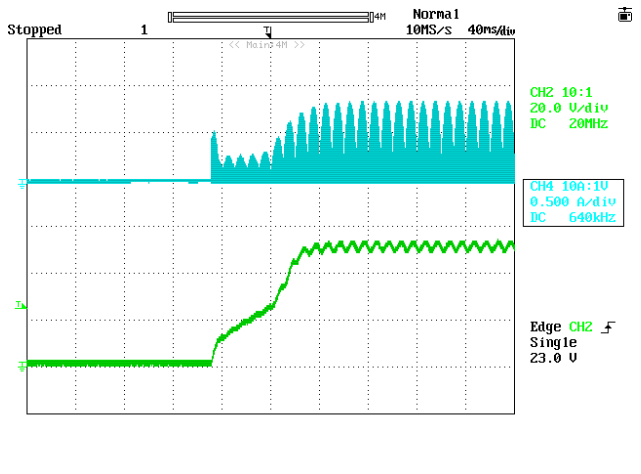

Figure 27 – 265 VAC, Full Load.
 Upper: I_{RIPPLE} , 0.5 A / div.
 Lower: V_{OUTPUT} , 20 V, 40 ms / div.



12.5 Output Current and Drain Voltage at Shorted Output

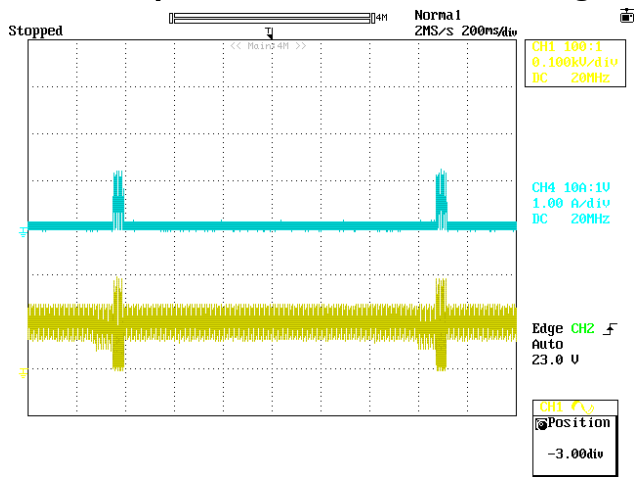

Figure 28 – 90 VAC, Full Load.
Upper: I_{OUTPUT} , 1 A / div.
Lower: V_{DRAIN} , 100 V, 200 ms / div.

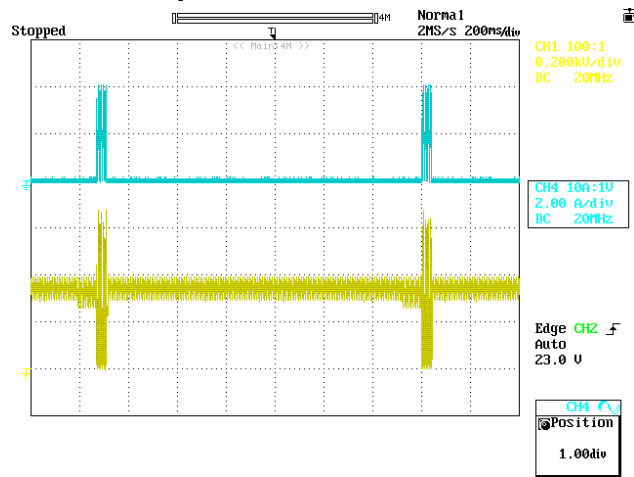

Figure 29 – 265 VAC, Full Load.
Upper: I_{OUTPUT} , 2 A / div.
Lower: V_{DRAIN} , 200 V, 200 ms / div.

12.6 Open Load Output Voltage

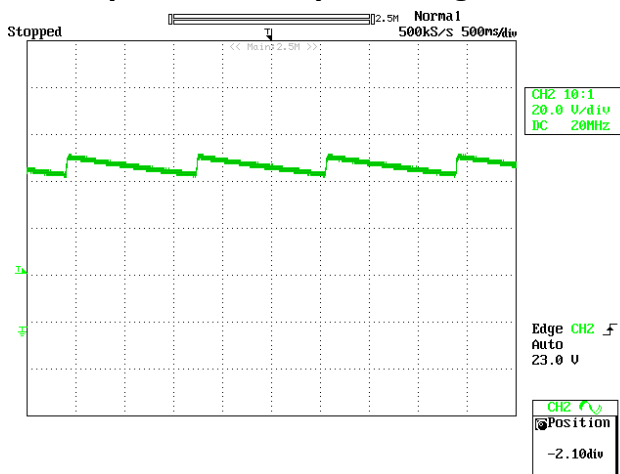

Figure 30 – Output Voltage: 115 VAC.
 V_{OUT} , 20 V / div., 500 ms / div.

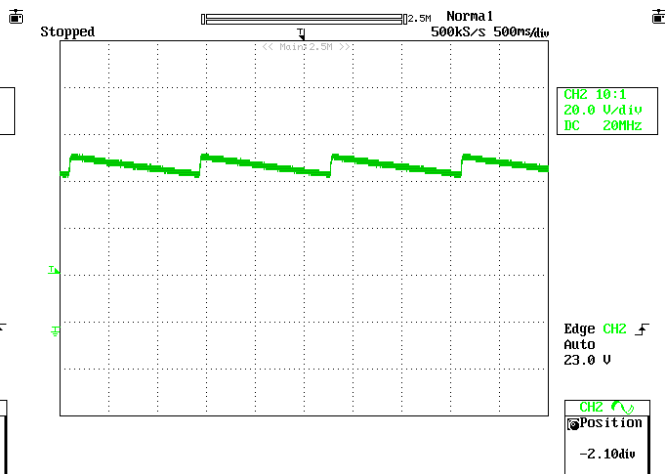

Figure 31 – Output Voltage: 230 VAC.
 V_{OUT} , 20 V / div., 500 ms / div.



13 Conducted EMI

The measurement was taken with the supply operating at full load with the board placed 10 mm away and oriented at 90 degrees to a metal plate connected to AC ground.

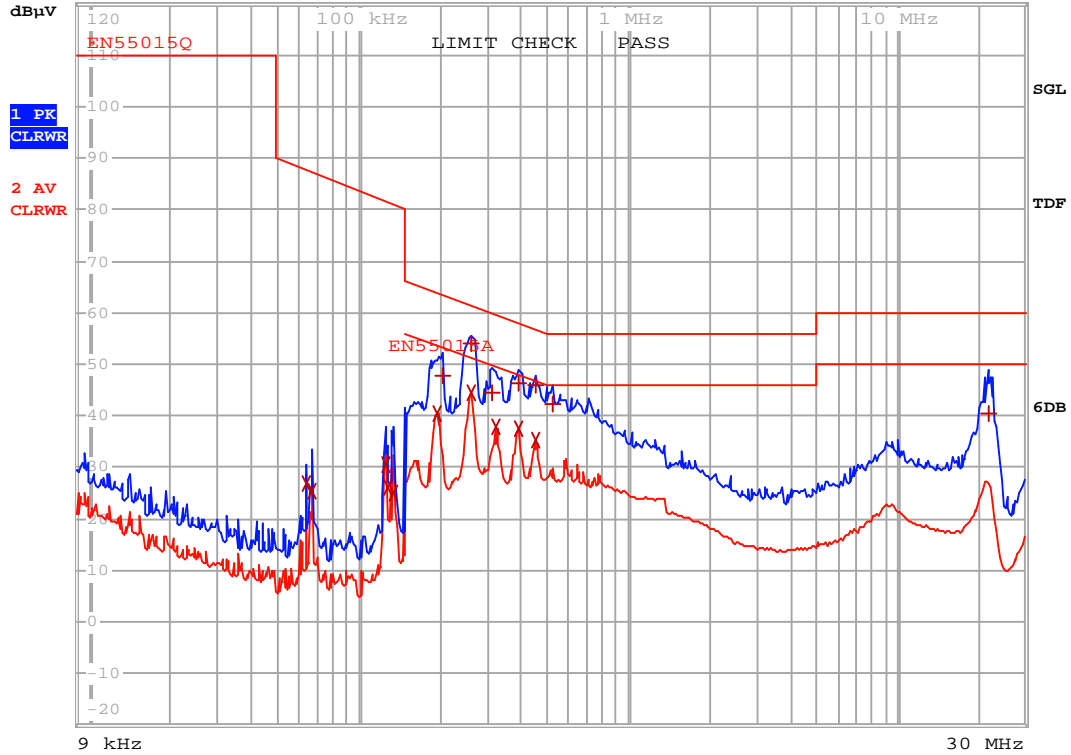

Figure 32 – Conducted EMI, Maximum Steady State Load, 115 VAC, 60 Hz



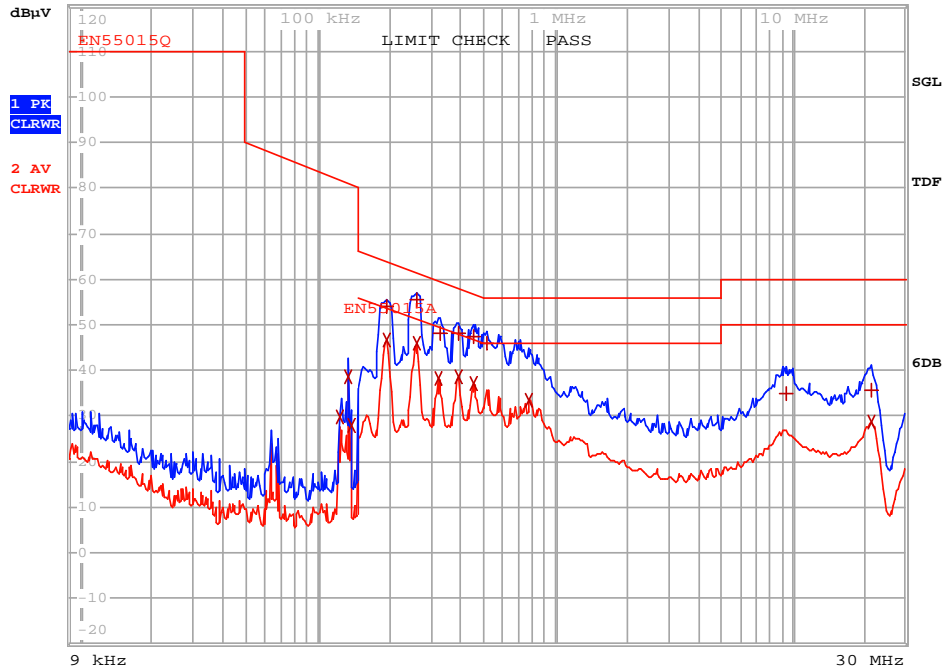

Figure 33 – Conducted EMI, Maximum Steady State Load, 230 VAC, 50 Hz.



14 Radiated EMI

Note: Refer to table for margin to standard – red line is peak measurement but limit line is quasi peak. RFI test data is for whole system, the demo board is assembly into T8 LED with aluminum shell, maximum steady state load.

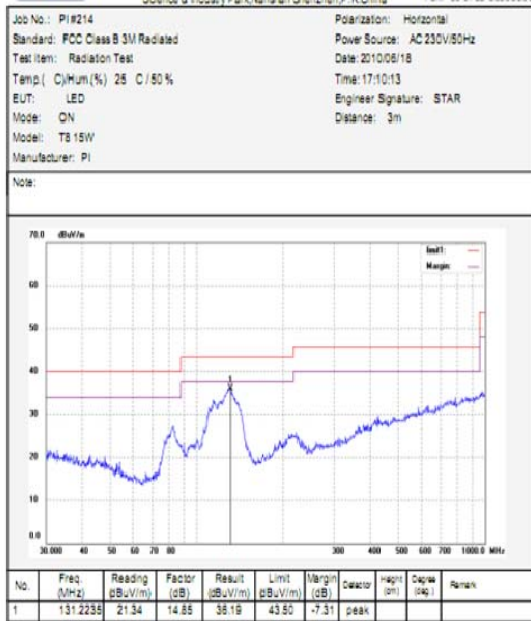

Figure 34 – 115 V / 60 Hz, Horizontal.

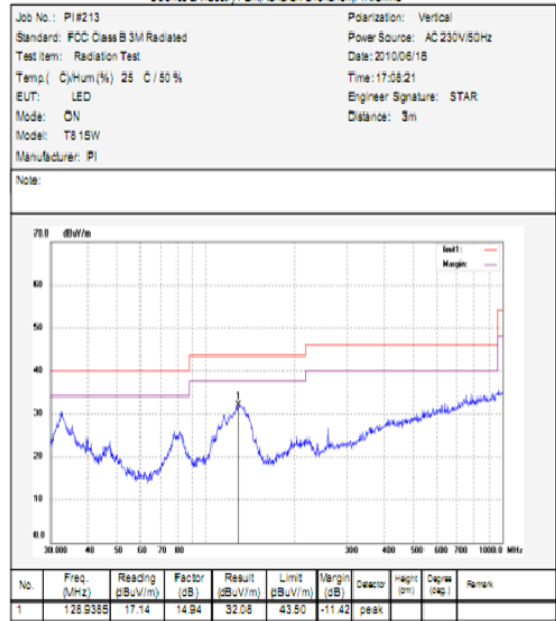

Figure 35 – 115 V / 60 Hz, Vertical.

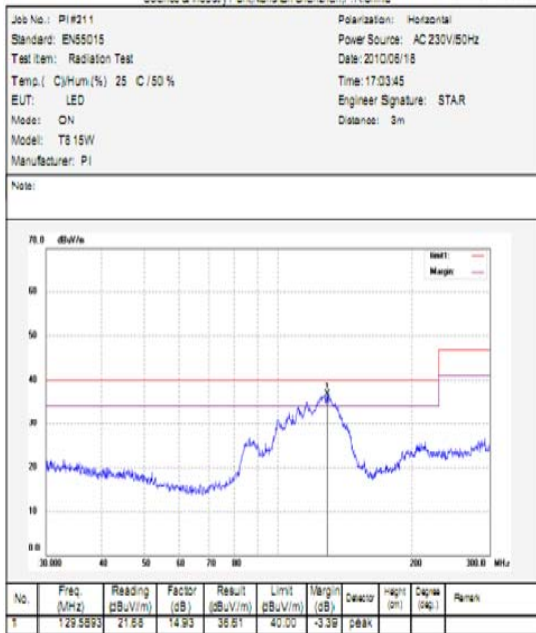

Figure 36 – 230 V / 50 Hz, Horizontal.

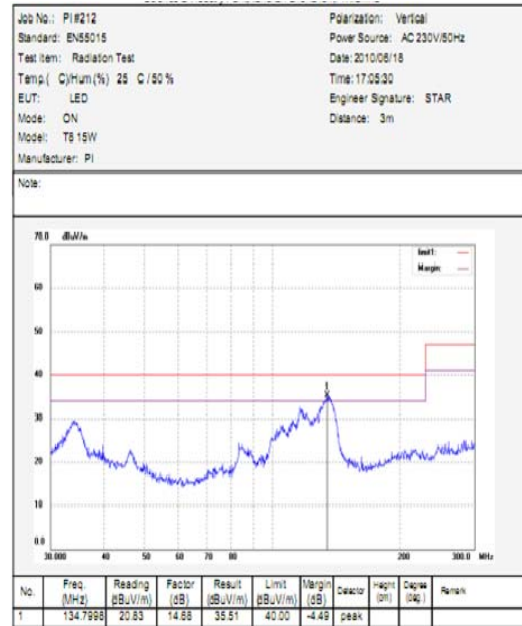

Figure 37 – 230 V / 50 Hz, Vertical.



15 Revision History

Date	Author	Revision	Description & changes	Reviewed
07-Oct-10	KM	1.2	Initial Release	Apps & Mktg



For the latest updates, visit our website: www.powerint.com

Power Integrations reserves the right to make changes to its products at any time to improve reliability or manufacturability. Power Integrations does not assume any liability arising from the use of any device or circuit described herein. POWER INTEGRATIONS MAKES NO WARRANTY HEREIN AND SPECIFICALLY DISCLAIMS ALL WARRANTIES INCLUDING, WITHOUT LIMITATION, THE IMPLIED WARRANTIES OF MERCHANTABILITY, FITNESS FOR A PARTICULAR PURPOSE, AND NON-INFRINGEMENT OF THIRD PARTY RIGHTS.

PATENT INFORMATION

The products and applications illustrated herein (including transformer construction and circuits external to the products) may be covered by one or more U.S. and foreign patents, or potentially by pending U.S. and foreign patent applications assigned to Power Integrations. A complete list of Power Integrations' patents may be found at www.powerint.com. Power Integrations grants its customers a license under certain patent rights as set forth at <http://www.powerint.com/ip.htm>.

The PI Logo, TOPSwitch, TinySwitch, LinkSwitch, DPA-Switch, PeakSwitch, EcoSmart, Clampless, E-Shield, Filterfuse, StackFET, PI Expert and PI FACTS are trademarks of Power Integrations, Inc. Other trademarks are property of their respective companies. ©Copyright 2010 Power Integrations, Inc.

Power Integrations Worldwide Sales Support Locations

WORLD HEADQUARTERS

5245 Hellyer Avenue
San Jose, CA 95138, USA.
Main: +1-408-414-9200
Customer Service:
Phone: +1-408-414-9665
Fax: +1-408-414-9765
e-mail:
usasales@powerint.com

GERMANY

Rueckertstrasse 3
D-80336, Munich
Germany
Phone: +49-89-5527-3911
Fax: +49-89-5527-3920
e-mail:
eurossales@powerint.com

JAPAN

Kosei Dai-3 Building
2-12-11, Shin-Yokohama,
Kohoku-ku, Yokohama-shi,
Kanagawa 222-0033
Japan
Phone: +81-45-471-1021
Fax: +81-45-471-3717
e-mail: japansales@powerint.com

TAIWAN

5F, No. 318, Nei Hu Rd., Sec. 1
Nei Hu District
Taipei 114, Taiwan R.O.C.
Phone: +886-2-2659-4570
Fax: +886-2-2659-4550
e-mail:
taiwansales@powerint.com

CHINA (SHANGHAI)

Rm 1601/1610, Tower 1
Kerry Everbright City
No. 218 Tianmu Road West
Shanghai, P.R.C. 200070
Phone: +86-021-6354-6323
Fax: +86-021-6354-6325
e-mail:
chinasales@powerint.com

INDIA

#1, 14th Main Road
Vasanthanagar
Bangalore-560052
India
Phone: +91-80-4113-8020
Fax: +91-80-4113-8023
e-mail:
indiasales@powerint.com

KOREA

RM 602, 6FL
Korea City Air Terminal B/D, 159-6
Samsung-Dong, Kangnam-Gu,
Seoul, 135-728
Korea
Phone: +82-2-2016-6610
Fax: +82-2-2016-6630
e-mail: koreasales@powerint.com

UNITED KINGDOM

1st Floor, St. James's House
East Street,
Farnham Surrey, GU9 7TJ
United Kingdom
Phone: +44 (0) 1252-730-141
Fax: +44 (0) 1252-727-689
e-mail:
eurossales@powerint.com

CHINA (SHENZHEN)

Rm A, B & C 4th Floor, Block C,
Electronics Science and
Technology Building
2070 Shennan Zhong Road
Shenzhen, Guangdong,
P.R.C. 518031
Phone: +86-755-8379-3243
Fax: +86-755-8379-5828
e-mail:
chinasales@powerint.com

ITALY

Via De Amicis 2
20091 Bresso MI
Italy
Phone: +39-028-928-6000
Fax: +39-028-928-6009
e-mail:
eurossales@powerint.com

SINGAPORE

51 Newton Road,
#15-08/10 Goldhill Plaza
Singapore, 308900
Phone: +65-6358-2160
Fax: +65-6358-2015
e-mail:
singaporesales@powerint.com

APPLICATIONS HOTLINE

World Wide +1-408-414-9660

APPLICATIONS FAX

World Wide +1-408-414-9760

